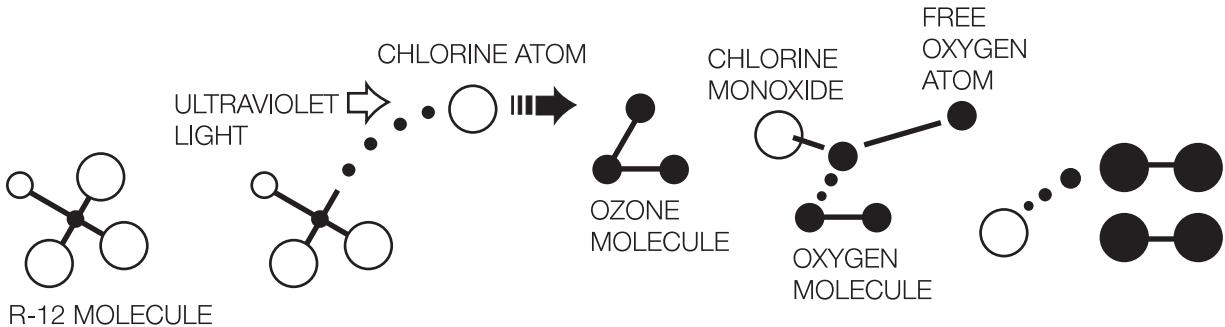

TABLE OF CONTENTS

Subject	Page
Refrigerant Handling Certification Requirements	55
Leak Detectors	59
Temperature Sensing Equipment	60
Safety Precautions	62
Ambient Temperature/Relative Humidity Chart	65
Non-Approved Air Conditioning Refrigerants	70
Verified System Malfunction Follow-up	72
Basic Troubleshooting	73

A serious environmental problem has been created by discharging R-12 refrigerant into the atmosphere. CFC's cause very long-term damage to the stratospheric ozone layer.



One CFC Molecule Destroys Many Ozone Molecules

One molecule of R-12 can destroy many molecules of ozone. In the upper atmosphere, ultraviolet light breaks off a chlorine atom from an R-12 molecule.

The chlorine attacks an ozone molecule, breaking it apart. An ordinary oxygen molecule and a molecule of chlorine monoxide are formed.

A free oxygen atom breaks up the chlorine monoxide. The chlorine is then free to repeat the process.

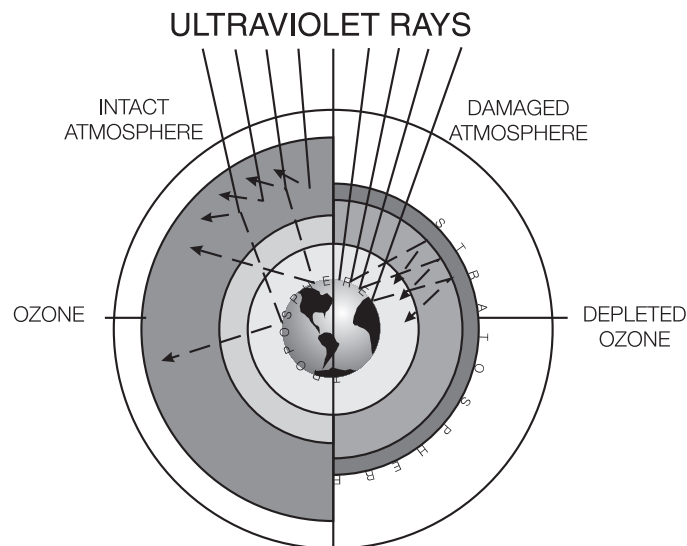

Damage to Stratospheric Ozone Allows UV-B Penetration

The ozone in the stratosphere blocks most of the ultraviolet-B radiation from the sun, thus preventing it from damaging plants and animals. Without the protection of stratospheric ozone, plants and animals are exposed to damaging levels of UV-B.

R-134a

For this reason, a new refrigerant, R-134a, has been developed. It does not contain chlorine (it's a "hydrofluoro-carbon," or "HFC"). It causes much less damage to stratospheric ozone.

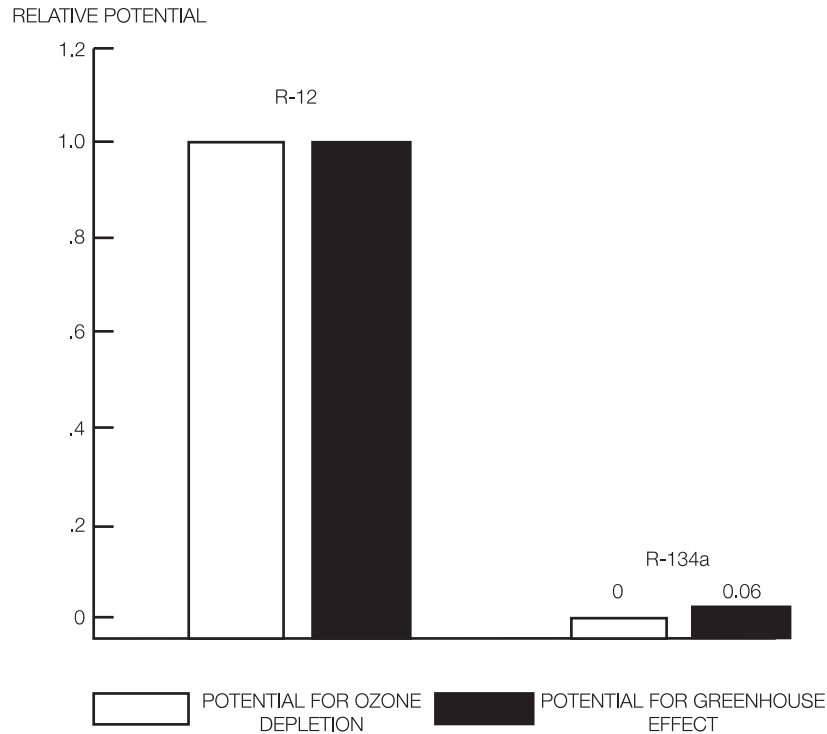

Environmental Compatibility of R-12 and R-134a

Despite the much lower risk of environmental damage, it's still important to handle R-134a responsibly. BMW technicians should do their part to maintain a safe environment for future generations.

Characteristics of R-134a:

- Very durable.
- Transports heat very efficiently
- Density, pressure, boiling point similar to R-12.
- Extremely hygroscopic (absorbs water very readily).
- Non-toxic, non-flammable; slight ether-like smell.
- Contains no chlorine atoms; will not damage stratospheric ozone.
- R-134a pressures tend to rise sooner and higher as temperature increases.

PHYSICAL CHARACTERISTICS	R-12	R-134a
Boiling Point (typical, sea level)	-22° F	-15° F
Density (at 68° F)	11 lb./gal.	10 lb./gal.
Latent Heat of Vaporization (at 32° F)	318 BTU/lb.	413 BTU/lb.
Saturation Vapor Pressure (at 194° F)	383 psi	467 psi
Molecular Size	4.4 Å	4.2 Å

IDENTIFICATION OF R-12 AND R-134a CONTAINERS

CONTAINERS	R-12	R-134a
Color	Yellow	Light Blue
Fittings	7/16" -20 or 1/4" Flare-Type	1/2" -16 Acme

Although R-12 and R-134a are similar in some ways, the refrigerants must never be mixed or combined in any way.

BASIC SYSTEM DIFFERENCES: R-12 vs R-134a

- R-134a pressures are higher than R-12, as temperature increases.
- Compressor oils:
 - R-12 systems use mineral oil.
 - 134a systems use PAG oil.
- Underhood labels:
 - R-12: black.
 - R-134a: green.

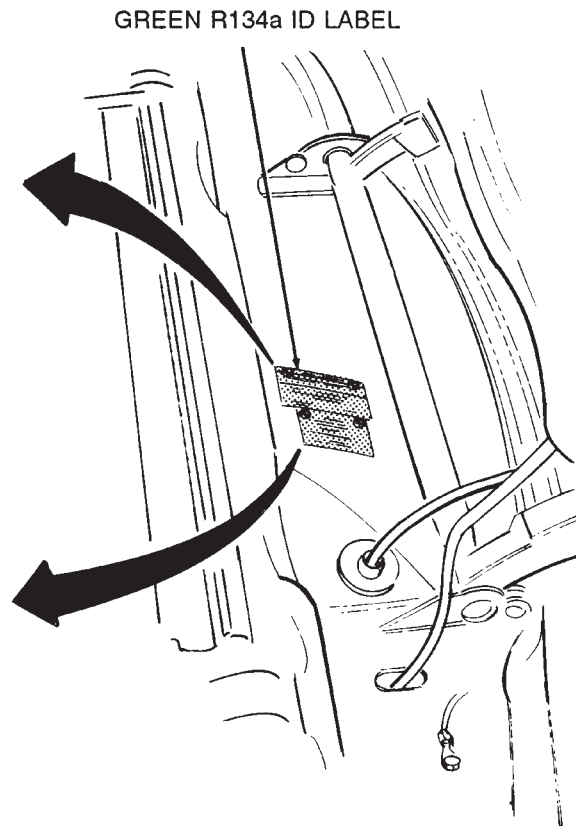
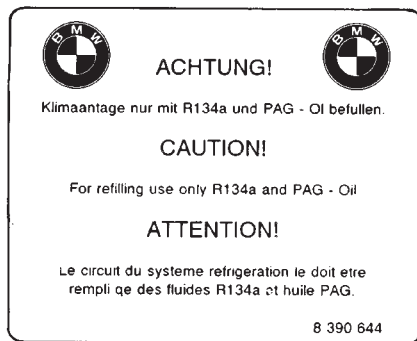

Green R-134a Underhood Label

NOTE: Charging amount should be according to the underhood label. However, refer to the S.I.B. # 64 2192 (3695) for refrigerant charge variations

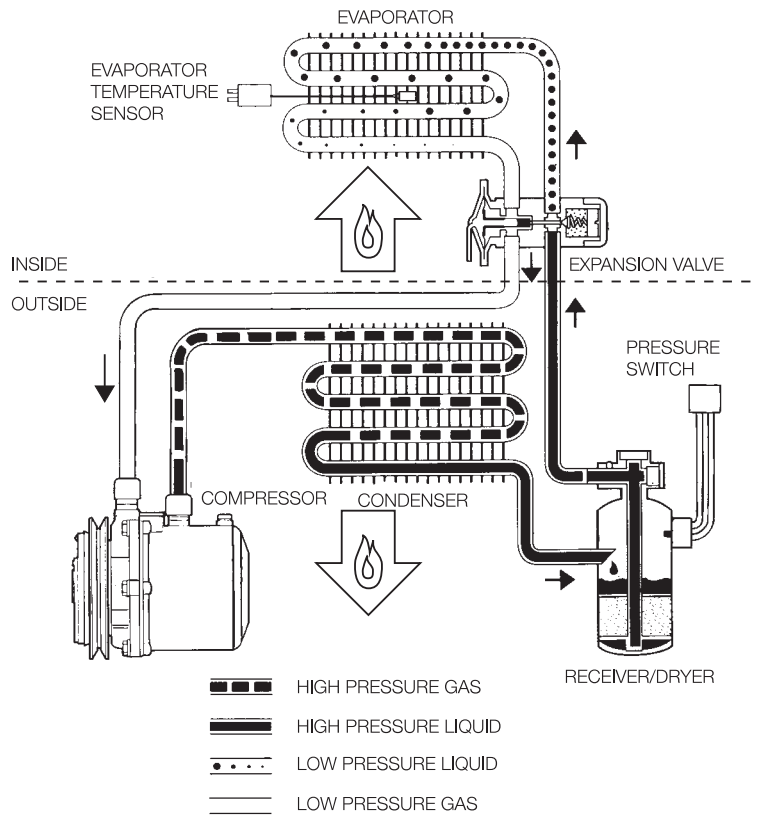

Description

Compressor Clutch
 Compressor
 Condenser
 Receiver/Dryer
 Hi/Lo Pressure Switch
 Expansion Valve
 Evaporator
 Temperature Sensor
 High Pressure gas, liquid
 Low Pressure liquid, gas

Changes

Higher torque capacity
 New valving, no melt bolts, PRV, PAG oil RBR seals
 High efficiency, no copper parts
 Zeolite desiccant, no melt bolts, PRV
 New seal materials (RBR)
 Special materials for R-134a, RBR seals
 Denser fins, high efficiency, no copper
 No changes
 Higher pressures at high temperature
 Higher heat to vaporize

REFRIGERANT HANDLING CERTIFICATION REQUIREMENTS

EQUIPMENT REQUIREMENT

Since Jan. 1, 1993, any technician servicing, repairing, or opening a motor vehicle air conditioning system “for consideration” - anything other than free service- must use either refrigerant recovery/recycling or recovery-only equipment approved by the EPA.

There are certification requirement for the technicians and the equipment; there are also record-keeping requirements.

TECHNICIAN TRAINING/CERTIFICATION

Technicians using approved equipment must be trained and certified by an EPA-approved organization, such as your BMW training center. To be certified, technicians must pass a test demonstrating their knowledge in the use of recycling equipment in compliance with SAE Standard J1989, the regulatory requirements, the importance of referant containment, and the effects of ozone depletion.

EQUIPMENT CERTIFICATION

The equipment owner or another responsible officer must certify (report) to the EPA that they own approved equipment. The information provided must include the name, address, and telephone number of the establishment where the recovery/recycling equipment is located; the name brand, model number, year and serial number(s) of the equipment acquired for use at the establishment; and the signature of the person who acquired the equipment (the owner or another responsible officer), certifying that they have acquired the equipment , that each individual authorized to use the equipment is properly trained, and that the information provided is true and correct.

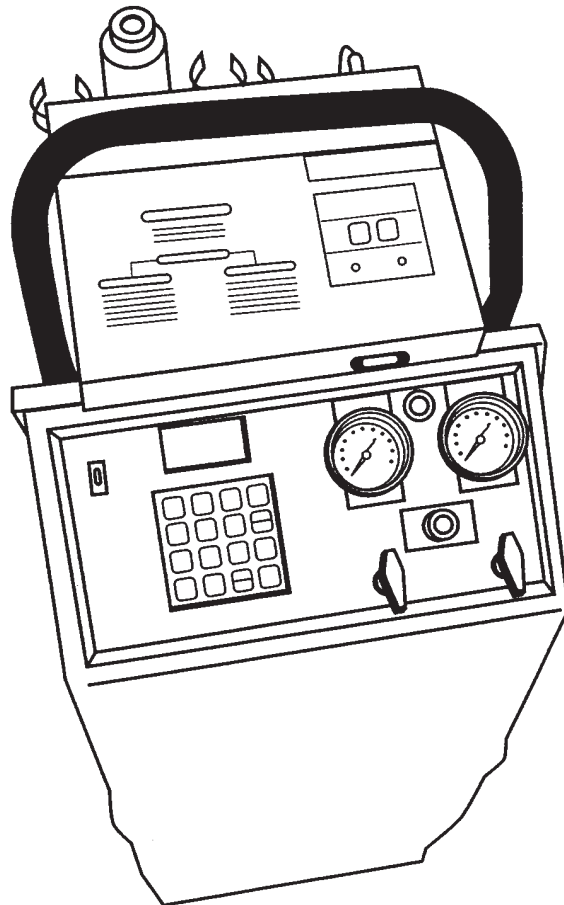

RECORD-KEEPING REQUIREMENTS

If the refrigerant is recovered and sent to a reclamation facility, the name and address of that facility must be retained.

IMPORTANT DATES

Jan. 1, 1992: Since this date, containment and recycling of R-12 have been required.

Nov. 14, 1994: Since this date, the sale of refrigerant in any size container is restricted to certified technicians.

July, 1995: Since this date, any R-12 mobile air conditioning system that is converted to use an acceptable alternate refrigerant must have the appropriate unique service fittings and label for that refrigerant.

Nov. 15, 1995: Since this date, recovery and recycling of any substitute substance for R-12, such as R-134a, used in a motor vehicle air conditioner have been required.

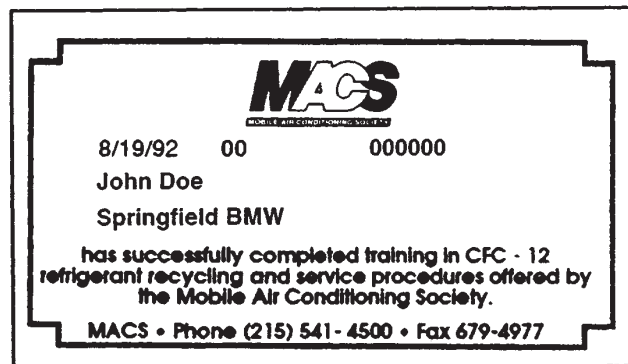

RECOMMENDED REFRIGERANT RECOVERY, RECYCLING, EVACUATION, AND CHARGING EQUIPMENT

A proper system charging station includes the following components:

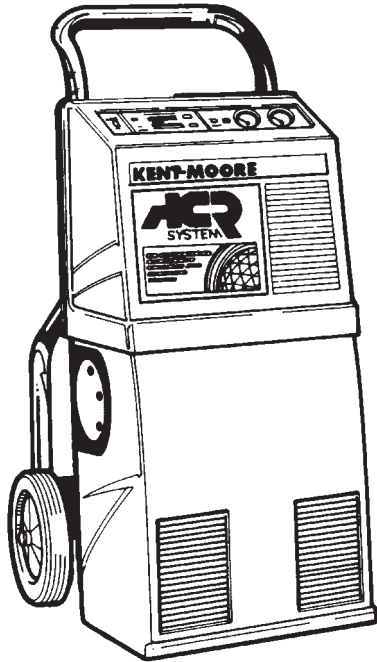

**Kent-Moore ACR3
Recovery/Recycling Station**

- A manifold gauge set.
- A charging cylinder.
- A bulk refrigerant supply tank.
- A vacuum pump.
- Hoses for connection to the automotive A/C system.
- An electronic leak detector.
- A thermometer.

This setup will allow you to evacuate and charge an A/C system.

For handling R-12 refrigerant, use an R-12 recycling unit (such as the Kent-Moore ACR³).

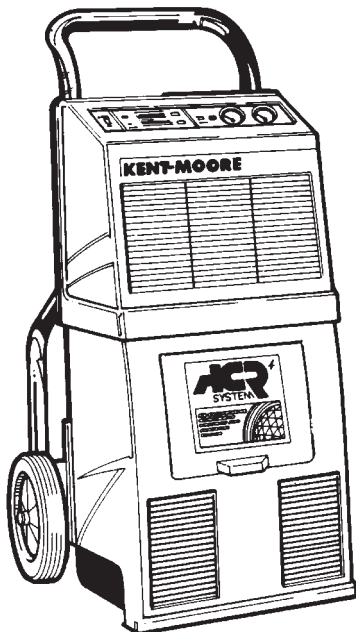

**ACR⁴ Recovery/
Recycling Station**

For R-134a refrigerant, a different unit is used (the Kent-Moore ACR⁴). These units filter and remove moisture the refrigerant, before discharging it into a recovery tank.

Never use any R-12 service tool, such as manifold gauge sets, on R-134a systems. Tools retain small amounts of refrigerant and lubricant. Attempting to use the same equipment on both R-12 and R-134a vehicles will contaminate the air conditioning systems. Manifold gauge sets must be constructed of the proper hose material and fitting to be compatible with R-134a. Compatible units should be labeled appropriately.

When servicing is completed, the protective sealing caps must always be reinstalled to prevent contamination via the service fittings.

The R134a system (early models) uses a standard sight glass to view the refrigerant charge. The sight glass view may turn “cloudy” if the wrong compressor oil is used.

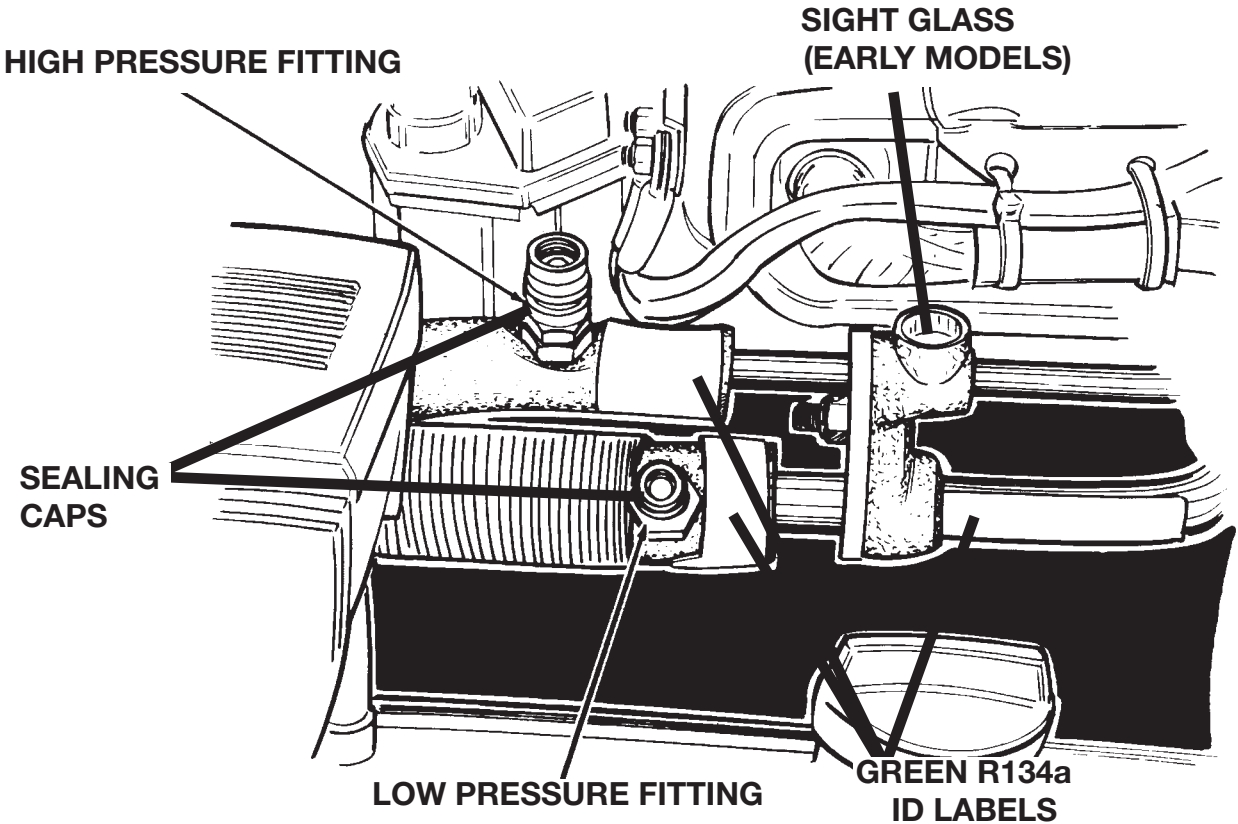

LEAK DETECTORS

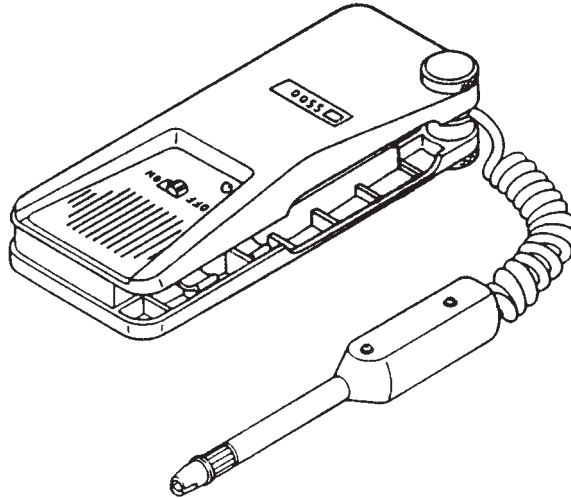

Typical Leak Detector

R-12 and R-134a systems use different leak detectors. An R-12 leak detector will not detect R-134a leaks (R-134a molecules are much smaller than R-12 molecules). However, an R-134a leak detector will detect R-12 leaks (be sure to follow the manufacturer's instructions carefully to avoid contamination).

An R-12 leak detector uses a very sensitive pickup which indicates the presence of Freon when placed below the leak: a white light illuminates or a warning buzzer sounds. It is easier to find a leak with the engine off, provided the pressure in the A/C system is 70-80 psi overall (slightly overcharged).

Always check for leaks with the engine off. The radiator fan of a running engine will circulate the refrigerant around making the leak point difficult to locate.

To check the evaporator, put the leak detector in the drain of the housing or in the center dash vent.

An R-134a leak detector has been tested and approved by BMW, TIF 5550. It automatically calibrates after it is turned on, and it detects leaks as small as 0.40 oz. of R-12 or R-134a per year.

BMW does not recommend the use of dyed refrigerant for finding a leak. The dyes can sometimes impair system operation and may damage the interior fabrics of the car.

TEMPERATURE SENSING EQUIPMENT

Correct climate control diagnosis requires an accurate and reliable temperature sensing device. A high quality analog thermometer or a digital pyrometer is recommended.

TYPICAL USE: A/C PERFORMANCE QUICK CHECK

Test conditions = 90°F & 50% Humidity

- Note ambient temperature
- Close all windows and doors.
- Engine Speed = 1500-2000 RPM.
- Blower Volume = Medium Speed
- Temperature Wheel = "Max Cold"
- "Snowflake" Button = A/C On
- Test conditions > 3 minutes

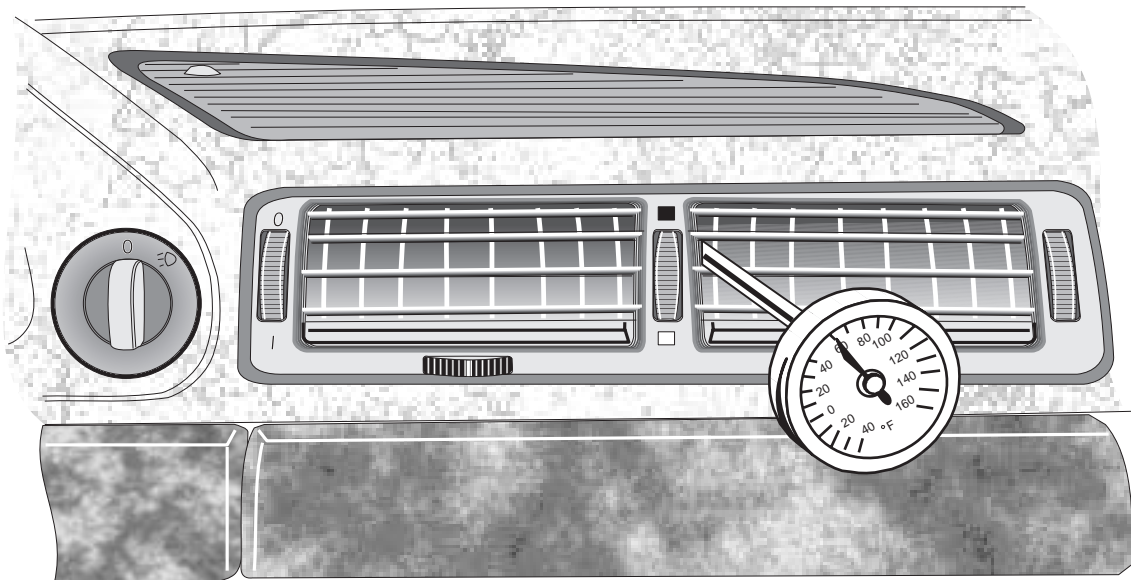
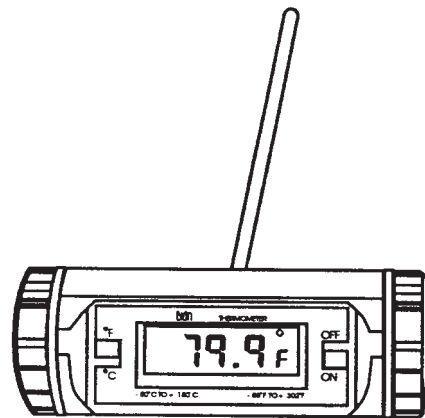
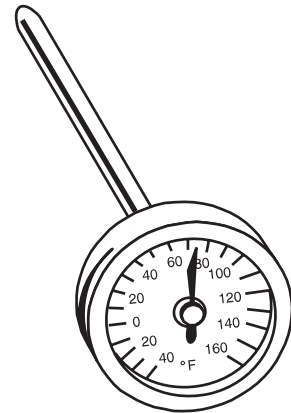

- Center vent discharge = . 20°F less than the ambient temperature.

DIS TEMPERATURE PROBE

The Diagnosis and Information System (DIS) tester is equipped with a temperature sensor cable, stored in the compartment at the rear of the tester. It can be used to measure the temperatures of liquids and gasses from -20° to 200°C.

To use the DIS as a thermometer:

- Select “Measurement System” button on the DIS start screen.
- Select “Temperature C” button on the “Measuring System Multimeter” screen.

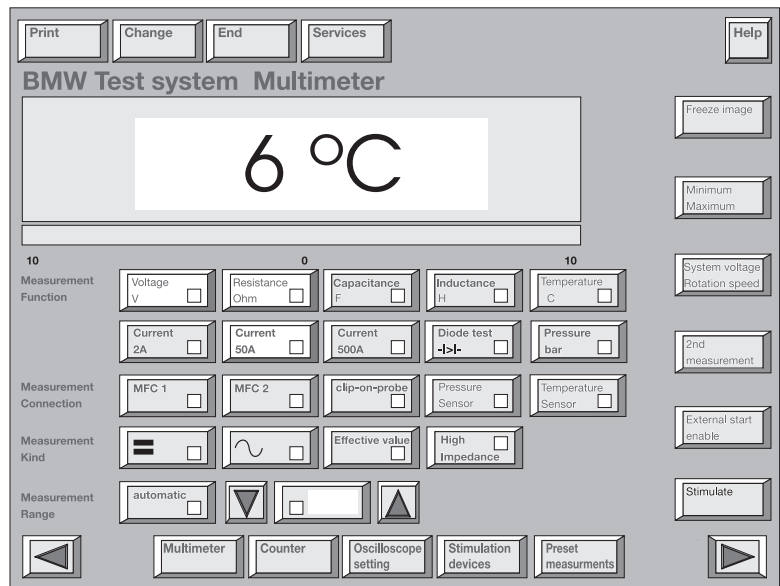
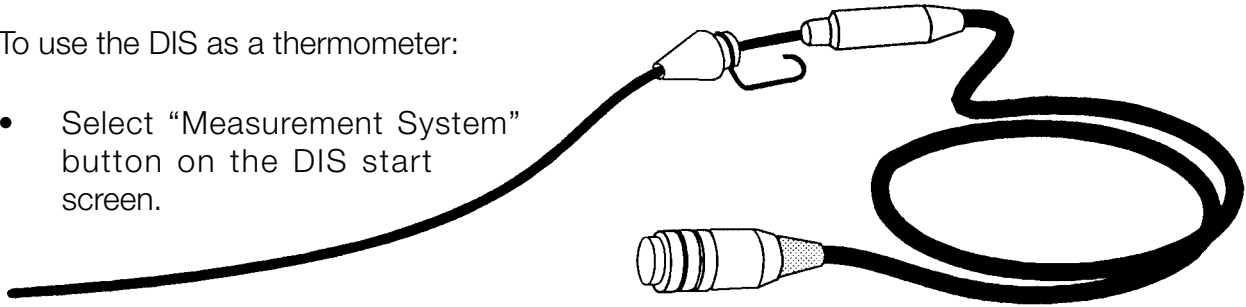

COOLING / HEAT GUN

To simulate testing temperatures use the approved “Heating/Cooling Gun Kit,

(Reference SI Bulletin 04 14 89.)

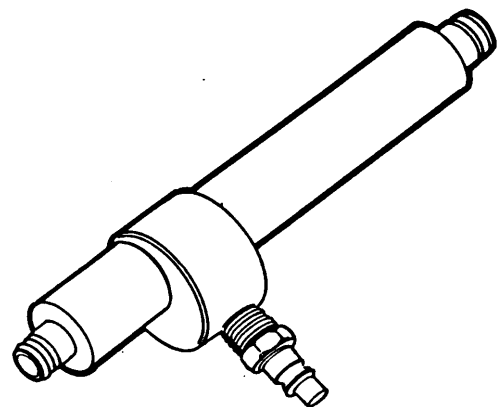

SAFETY PRECAUTIONS

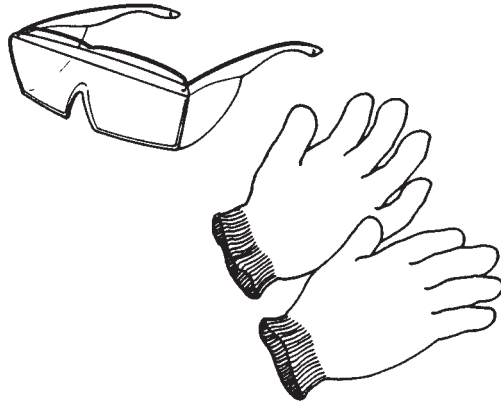

Always Use Eye Protection and Gloves

The following safety precautions should be observed when working on an automotive refrigeration system:

- Always wear eye protection and gloves while handling refrigerant or servicing an air conditioning system.
- Avoid breathing R-134a vapor or mist; exposure may irritate eyes, nose, throat, and lungs.
- If refrigerant or compressor oil contacts the skin or eyes, rinse the affected area with warm water, administer first aid immediately, and consult a doctor.
- Use only approved service equipment to discharge A/C systems.
- If an accidental discharge occurs, ventilate the work area.
- Store refrigerant service equipment and bulk supply containers in a cool, dry location away from direct sunlight and other heat sources (<113° F, (45° C)).
- Do not expose refrigerants to an open flame, since burning refrigerant can produce poisonous gas. This includes open flames (such as in a propane leak detector), portable heaters, and lit cigarettes.
- Do not pressure-test service equipment or vehicle A/C systems with an air/R-134a mixture. Some mixtures of air and R-134a are combustible at elevated pressures. The use of compressed air for leak detection in an R-134a system could result in a fire or explosion.

Do not discharge refrigerant into the atmosphere; contain it. R-134a is heavier than air; if discharged into the atmosphere, it can replace the air, causing suffocation. If R-12 is discharged into the air it damages the environment.

- Never weld or steam-clean any part of the air conditioning system. Heating the refrigerant in a closed system could cause an explosion, due to the increased pressure.
- Always consider R-12 or R-134a to be under high pressure, whether in the automobile refrigeration system, service equipment, or refrigerant storage containers.
- R-134a should only be handled by competent, informed personnel using approved procedures and equipment. Failure to do so may result in serious injury and/or substantial equipment or vehicle damage.
- Removal of R-134a must be carried out using R-134a equipment that meets the requirements of SAE J2210.
- If accidental discharge occurs, ventilate the work area before resuming service. Exposure to high concentrations of refrigerant vapor can induce anesthetic effects such as weakness, dizziness, and nausea.

The R134a service fittings are a unique design and prohibit the connection of non-approved equipment. The large diameter metric fitting is the high side (also sight glass) while the smaller diameter fitting is the low side.

HIGH PRESSURE FITTING

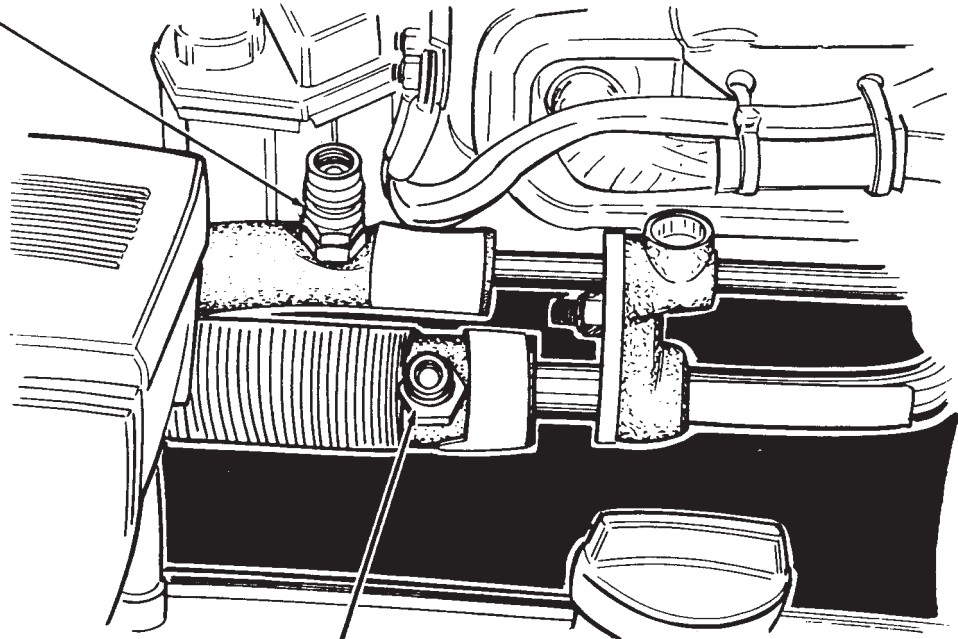

LOW PRESSURE FITTING

The ACR4 unit has approved quick disconnect hose connectors which correspond to the special R134a service fittings found on the vehicle. This arrangement prevents the accidental connection of R12 service equipment. **No attempt should ever be made to bypass these special fittings**

Refer to S.I.B. # 641392 (3646) for nominal air conditioning system pressures R12/R134a

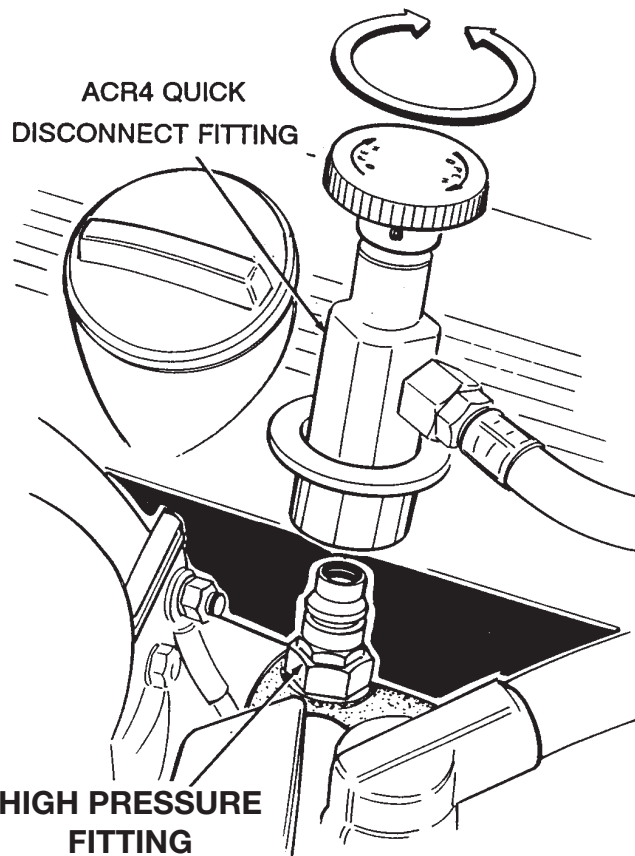

AMBIENT TEMPERATURE / RELATIVE HUMIDITY REFERENCE CHART

Relative Humidity (%)	Outside Air Temp (°F)	R-12 Discharge Temp(°F)	R-12 Low Pressure (psi)	R-12 High Pressure (psi)	R-134a Discharge Temp (F)	R-134a Low Pressure (psi)	R-134a High Pressure (psi)
20	70	44	24	143	44	9	69
	80	44	31	192	44	24	85
	90	50	45	232	47	40	136
	100	59	47	270	53	50	231
	110	66	57	320	64	58	308
30	70	44	23	154	44	10	80
	80	44	35	203	44	28	110
	90	54	47	239	48	42	168
	100	63	50	283	59	54	253
	110	74	60	334	69	62	328
40	70	44	34	170	45	12	93
	80	50	40	216	50	32	149
	90	58	48	146	56	45	212
	100	67	53	291	64	57	264
	110	77	63	350	74	67	348
50	70	46	37	178	45	14	102
	80	55	43	223	51	36	164
	90	61	50	252	59	54	229
	100	71	58	312	70	67	229
	110	84	66	365	80	76	368
60	70	47	40	187	45	18	133
	80	55	49	230	53	39	191
	90	64	54	266	62	57	249
	100	75	60	318	72	72	310
	110	86	68	383	83	80	384
70	70	47	41	228	46	19	168
	80	56	50	257	56	42	215
	90	66	56	278	67	61	260
	100	78	63	333	77	75	321
	110	91	72	402	87	87	390
80	70	47	43	247	46	21	178
	80	57	53	268	57	47	218
	90	69	62	287	69	67	267
	100	82	70	340	78	80	331
	110	95	76	438	90	89	405
90	70	48	44	258	46	33	183
	80	60	55	286	59	54	223
	90	72	63	307	71	69	274
	100	85	72	350	84	84	345
	110	101	80	463	87	94	424

COMPLAINT:

Cooling is not adequate.

CONDITION:

- The low-side gauge reading is low, or may go into a vacuum.
- The high-side gauge reading increases as the system operates.
- The discharge air from the evaporator is only slightly cool.
- The expansion valve inlet may show heaving sweating or frost.
- The high-pressure side is abnormally hot.

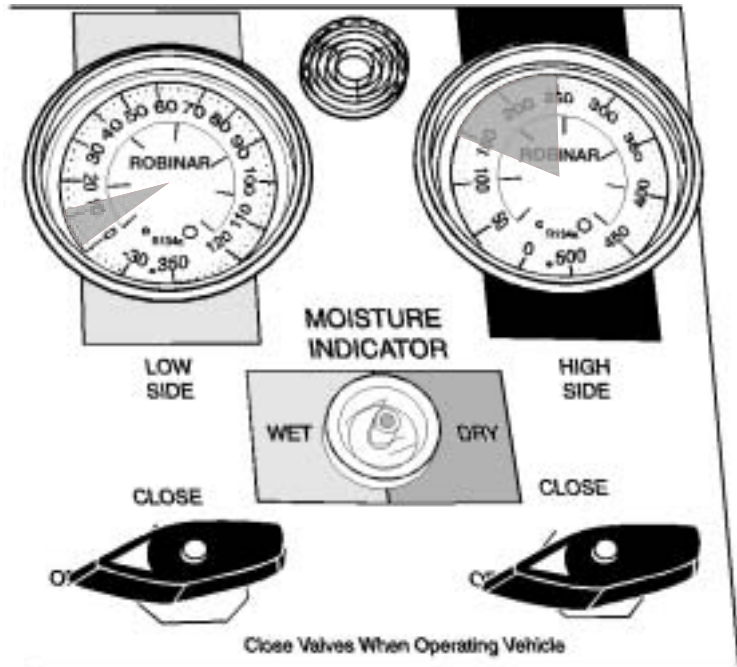

DIAGNOSIS:

- The expansion valve is stuck closed; or is plugged by moisture, ice, or foreign material.

CORRECTION:

1. Recover the refrigerant from the system.
2. If the condition described on page 28 exist, replace the receiver/dryer.
3. Evacuate the system for a minimum of 30 minutes* and recharge it.
4. Operate the system and check its performance.
5. If the system fails to function correctly, replace the expansion valve.

**Longer periods of applied vacuum are better.*

COMPLAINT:

Cooling is not adequate.

CONDITION:

- The low-side gauge reading is too high.
- The high-side gauge reading is too low.
- The sight glass is free of bubbles; the system is fully charged. (If equipped)
- The discharge air from the evaporator is not sufficiently cool.

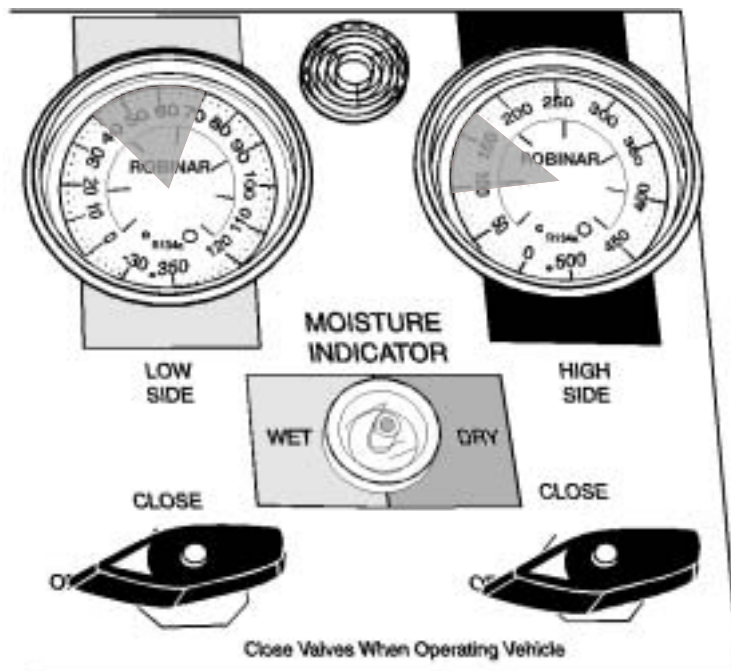

DIAGNOSIS:

- There may be a leak in the compressor, or the drivebelt may be loose/worn. The compressor pistons, rings, valves, or cylinders may be excessively worn or scored.

CORRECTION:

1. Check the compressor for noisy or knocking operation.
2. Recover the refrigerant from the system..
3. Remove and replace the compressor, if it is noisy/knocking.
4. Examine the condenser for metal fragments - clean if required.
5. Replace the receive/dryer.
6. Evacuate the system for a minimum of 30 minutes* and recharge it.
7. Operate the system and check its performance.

**Longer periods of applied vacuum are better.*

COMPLAINT:

Cooling is not adequate.

CONDITION:

- The low-side gauge reading is excessively high.
- The high-side gauge reading is excessively high.
- Bubble may appear occasionally in the sight glass. (if equipped)
The liquid line is very hot.
- The discharge air from the evaporator is warm

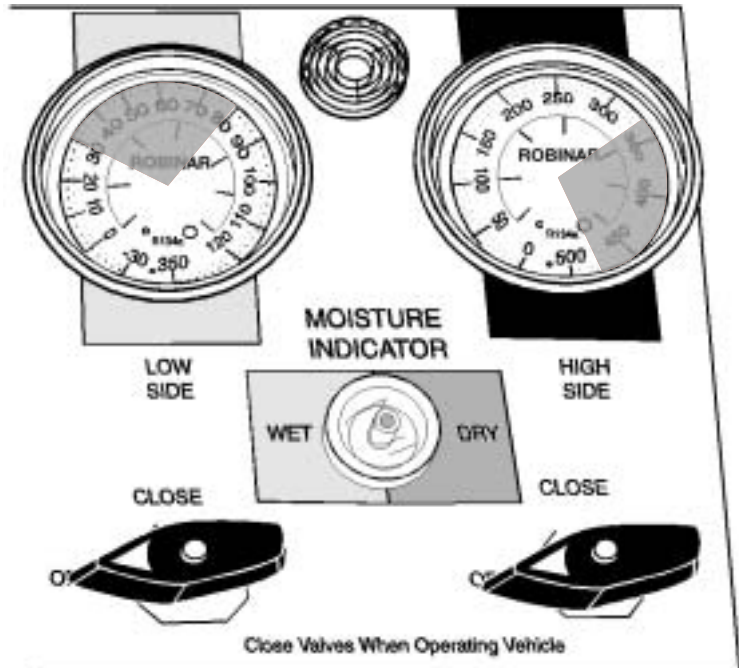

DIAGNOSIS:

- The system may be overcharged
- The condenser may not be operating properly.
- Air flow through the condenser may be poor.
- The auxiliary fan may not be operating properly.

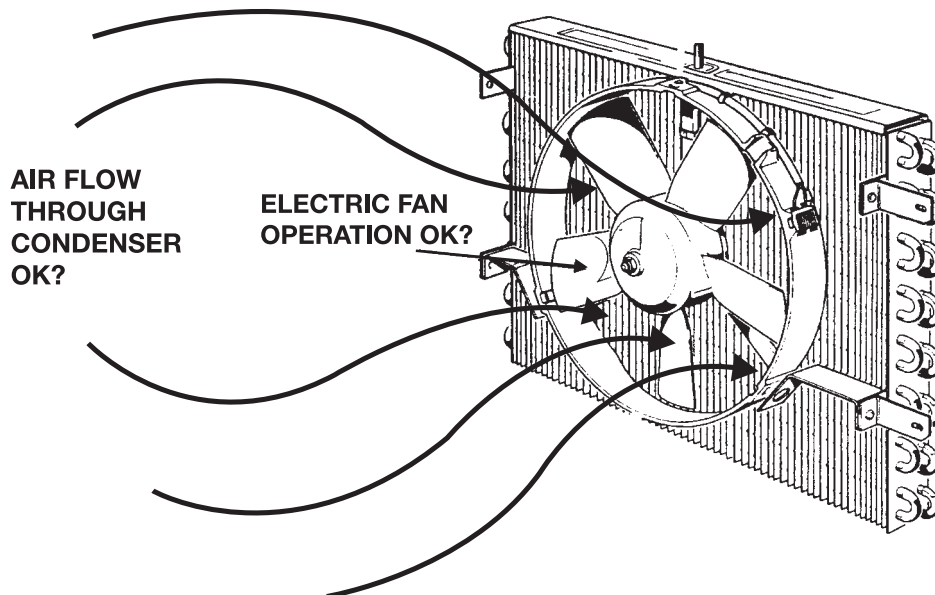

CORRECTION:

1. Recover the refrigerant.
2. Recharge the refrigerant according to the underhood label or the specifications in TIS.
3. Operate the system and check its performance.

If the gauge readings are still to high:

1. Recover the refrigerant.
2. Blow shop air through the condenser to check whether its passages are free. A condenser can be clogged by debris, such as fragments from a failed compressor valve or desiccant from the receiver/dryer. If the condenser passages are clogged, replace it. Determine what material clogged the condenser.
3. Replace the receiver/dryer.
4. Evacuate the system for a minimum of 30 minutes* and recharge it.
5. Operate the system and check its performance.

**Longer periods of applied vacuum are better.*

NON-APPROVED AIR CONDITIONING REFRIGERANTS

Recently, “alternative” refrigerants for automatic air conditioning have been marketed in certain areas. These refrigerants are claimed to be compatible replacements for the BMW-approved R-12 refrigerant (also known as Freon). The “alternative” refrigerants usually consist of a mixture of various components; among them may be R-12, R-22, R-142b, R-176, isobutane, propane or ammonia.

These refrigerant components are not related to, and not as ecologically sound as, the new R-134a refrigerant.

THIS TYPE OF “ALTERNATIVE” REFRIGERANTS IS NOT COMPATIBLE WITH, AND NOT APPROVED FOR USE IN BMW AIR CONDITIONING SYSTEMS.

Problems that can occur when charging a BMW air conditioning system with an alternative mix or “blend”:

1. R-22 is incompatible with the existing R-12 desiccant found in BMW receiver-dryers. The desiccant will break down, and may be distributed through the A/C system, clogging the expansion valve and destroying the compressor. Some products use “sealants” which can clog orifices in both the vehicle and recycling equipment.
2. R-22 can result in substantially higher pressure when installed in a system designed for R-12, especially in stop-and-go traffic in high ambient temperatures.
3. Current R-12 hoses, O-rings and sealing materials found on BMW vehicles are not designed to, and do not, retain R-22. The R-22 permeates out of the hoses. If the R-12 is then lost from the system, the remaining R-142b is flammable.
4. If a vehicle with a non-approved refrigerant is brought into a shop and connected to recycling equipment, the same problems can occur with the recycling equipment. In addition, the “alternative” refrigerant can be passed on to other vehicles that are connected to the same recycling equipment. This could spread the problems to other vehicles.
5. Materials such as propane and isobutane are flammable. If the proper pressure and charge conditions are not maintained, these components “fractionate” out of the mixture. While the blended components may not be flammable, the individual components may be flammable if the mixture has fractionated.

-
6. Automotive A/C systems are subject to Federal law, as well as specific state requirements. Currently, 10 states and the District of Columbia have enacted requirements that generally follow SAE definitions and requirements. The SAE J639 standard requires that "...Blend refrigerants, both in the original composition and in the compositions created as a result of normal mobile air-conditioning operating conditions, must meet the previous [ASHRAE 34-78] criteria: low toxicity, nonflammable, and nonexplosive requirements."
 7. Blend refrigerants often require costly special processing to recycle. Since they cannot be vented to the atmosphere, servicing the system requires removal of the material into dedicated containers and shipping the material to a processing center for reclamation or destruction. The shipping must be done according to state and federal regulations, and the material is classified as a flammable gas for shipping purposes.

Solution:

There are currently no BMW-approved alternative refrigerants to R-12 or R-134a. Use of any refrigerant other than R-12 or R-134a will preclude warranty coverage of resulting failures.

Protect your customer's air conditioning systems as well as your own recycling equipment. Do not allow non-approved refrigerants to enter your recycling equipment.

If a customer has had air conditioning service performed elsewhere, determine that only approved refrigerant was used for recharging the system. This Service Information can be used to explain potential problems to customers.

SYSTEM CONVERSION

WHEN TO RETROFIT

As long as R-12 is available, it should be used to service a vehicle with an R-12 system. When R-12 supplies are unavailable, the customers may be willing to pay for a retrofit.

STANDARD RETROFIT

To achieve the most effective system retrofit, follow the instructions in Service Information Bulletin # 64 01 95 (4179). Retrofit kits have been developed for the E31, E32, E34, and E36 models, to provide comparable system performance. The kits include a new receiver/dryer, hoses, service fitting, refrigerant controls, and other parts.

VERIFIED SYSTEM MALFUNCTION FOLLOW-UP

After verifying that the complaint is actually a system malfunction, make the following “basic” checks:

VISUAL CHECKS

- Coolant level, coolant hoses in perfect condition and all drive belts tensioned properly.
- A/C condenser, radiator, and system microfilters clean and unobstructed.
- Auxiliary cooling fan operates with A/C on and rotates in the correct direction.
- Interior flow-through ventilation functions correctly, vent flap valves behind rear bumper open with interior overpressure.

DIS TESTER CHECKS

- Instrument cluster temperature gauge and Engine Control Module temperature value indicate engine coolant temperature is normal.
- IHKR/IHKA has no faults in memory and the system is not operating with stored substitute values.
- Water valves open/close correctly, heater core temperature sensors indicate that the heater cores cool down on system cue.
- Outlet flaps operate correctly, actual air discharge locations agree with tester indicated flap open/closed positions.
- A/C compressor clutch energizes on system cue with engine running. (Many systems will not energize the compressor clutch with the ignition switched on, engine not running.)

BASIC TROUBLESHOOTING

- Always personally verify the customer complaint.
- Always verify that the complaint is truly a system malfunction.
- Perform a Quick Test to determine if the vehicle systems have logged fault codes.
- Call the faulted system or appropriate test schedule to verify the correct control module is installed in the car.
- Follow the Diagnostic Information System (DIS) on screen instructions and perform all tests as specified.
- Use the DIS and fault symptom diagnostic procedures as trained.
- Follow the appropriate test module procedures for systems that malfunction but fail to set faults in memory.
- System problems which elude diagnostic procedures must be brought to the attention of BMW of North America, Inc.
- **BMW Technical Assistance Hotline 1-800-472-7222**